

DEWE[®]
DIAMOND DENTAL BURS

PRODUCT CATALOGUE

2026 Edition





SHARP



SMOOTH



LONG-LASTING



CERTIFIED

ABOUT DEWE

DEWE is an Indonesian-based manufacturer of diamond dental burs focused on quality and precision. We combine precision engineering with modern manufacturing technology to deliver consistent performance. Every bur undergoes comprehensive quality checks with full traceability from raw materials to finished goods. Our processes align with medical device industry best practices and the principles of Good Manufacturing Practices (CPAKB), Good Distribution Practices (CDAKB), as well as applicable medical device regulations. We are committed to being a trusted partner for dentists and clinics who prioritize quality and reliability.

DEWE adalah produsen diamond dental burs berbasis di Indonesia yang berfokus pada kualitas dan presisi. Kami memadukan manufaktur presisi dan teknologi modern untuk menghasilkan performa yang konsisten. Setiap bur menjalani pemeriksaan kualitas menyeluruh serta ketertelusuran rapi dari bahan baku hingga produk jadi. Proses kami selaras dengan praktik terbaik industri alat kesehatan dan prinsip-prinsip CPAKB, CDAKB serta regulasi yang berlaku. Kami berkomitmen menjadi mitra terpercaya bagi dokter dan klinik gigi yang mengutamakan kualitas dan keandalan.









































ILLUSTRATION	BUR SHAPE	CODE	PAGE
	ROUND	001	3
	ROUND with Collar	002	3
	INVERTED CONE Short Head	010	4
	INVERTED CONE with Collar	019	4
	DIABLO	032	5
	BUD , Pointed	033	5
	BARREL	039	6
	WHEEL	041	6
	WHEEL Rounded Rim	067, 068	7
	CYLINDER Flat End	109, 111	7
	CYLINDER Beveled	129, 130, 131	8
	CYLINDER Round End	139, 141	8
	CYLINDER Convex End	146	9
	CYLINDER End Cutting	150	9
	CYLINDER Round Edge	156, 158	10
	CONE , Pointed	165, 167	10
	TAPER , Flat End	170, 172	11
	TAPER , Round End	196, 198	11
	INVERTED CONE	225, 226	12





ILLUSTRATION	BUR SHAPE	CODE	PAGE
	PEAR	237, 238	12
	FLAME	247, 249	13
	BUD	257	13
	BUD, Slender	263	14
	EGG	277	14
	TORPEDO	288, 289, 290	15
	GINGIVAL CURETTAGE	297, 298, 299	15
	LENTICULAR	304	16
	INTERPROXIMAL	465	16
	POINTED FLAME	496	17
	CYLINDER, Guide Pin	508C	17
	TAPER, Guide Pin	508T	18
	CYLINDER, Gross Reduction	513	18
	TAPER, Gross Reduction	519	19
	FLAME NEEDLE, Short Head	539	19
	TAPER, Round Edge	544, 545, 546	20
	DEPTH MARKER	552	20
	ENDO ACCESS Pointed Cone Rounded Tip	E164	21
	ENDO ACCESS Safe End	E165	21

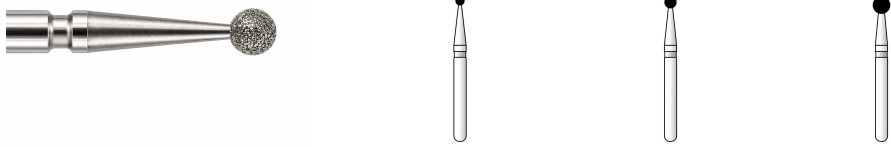
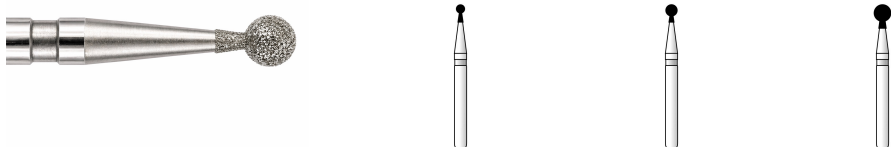
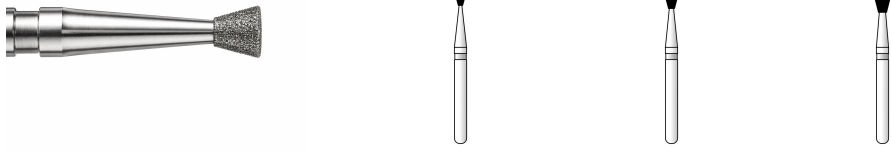
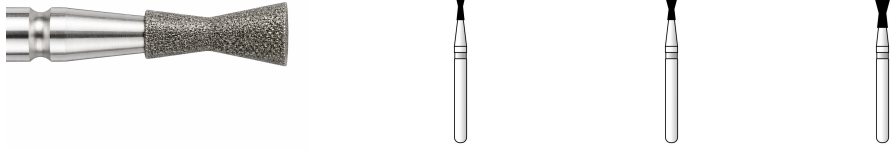

ROUND						
Friction Grip		001	001	001		
						
Diamond Diameter (mm)		1.2	1.6	2.3		
Diamond Length (mm)		1.2	1.6	2.3		
Overall Bur Length (mm)		19.0	19.0	19.0		
Grit Size	Super-fine	SF	001-012 SF	001-016 SF	001-023 SF	
	Fine	F	001-012 F	001-016 F	001-023 F	
	Medium	M	001-012 M	001-016 M	001-023 M	
	Coarse	C	001-012 C	001-016 C	001-023 C	



ROUND with Collar						
Friction Grip		002	002	002		
						
Diamond Diameter (mm)		1.2	1.6	2.3		
Diamond Length (mm)		2.4	2.4	3.2		
Overall Bur Length (mm)		19.0	19.0	19.0		
Grit Size	Super-fine	SF				
	Fine	F				
	Medium	M	002-012 M	002-016 M	002-023 M	
	Coarse	C	002-012 C	002-016 C	002-023 C	





INVERTED CONE Short Head						
Friction Grip		010	010	010		
						
Diamond Diameter (mm)		1.2	1.6	2.1		
Diamond Length (mm)		1.0	1.4	1.9		
Overall Bur Length (mm)		19.0	19.0	19.0		
Grit Size	Super-fine	SF				
	Fine	F				
	Medium	M	010-012 M	010-016 M	010-021 M	
	Coarse	C	010-012 C	010-016 C	010-021 C	



INVERTED CONE with Collar						
Friction Grip		019	019	019		
						
Diamond Diameter (mm)		1.2	1.6	2.1		
Diamond Length (mm)		3.0	3.0	4.0		
Overall Bur Length (mm)		19.0	19.0	19.0		
Grit Size	Super-fine	SF				
	Fine	F				
	Medium	M	019-012 M	019-016 M	019-021 M	
	Coarse	C	019-012 C	019-016 C	019-021 C	





DIABLO					
Friction Grip		032	032	032	
					
Diamond Diameter (mm)		1.2	1.6	2.0	
Diamond Length (mm)		1.2	1.8	2.5	
Overall Bur Length (mm)		19.0	19.0	19.0	
Grit Size	Super-fine	SF			
	Fine	F			
	Medium	M	032-012 M	032-016 M	032-020 M
	Coarse	C	032-012 C	032-016 C	032-020 C



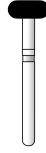

BUD, Pointed			
Friction Grip		033	
			
Diamond Diameter (mm)		2.7	
Diamond Length (mm)		7.0	
Overall Bur Length (mm)		21.0	
Grit Size	Super-fine	SF	
	Fine	F	033-027 F
	Medium	M	033-027 M
	Coarse	C	





BARREL				
Friction Grip		039	039	
  				
Diamond Diameter (mm)		3.7	4.7	
Diamond Length (mm)		7.0	7.0	
Overall Bur Length (mm)		21.0	21.0	
Grit Size	Super-fine	SF		
	Fine	F		
	Medium	M	039-037 M	039-047 M
	Coarse	C	039-037 C	039-047 C

WHEEL					
Friction Grip		041	041	041	
   					
Diamond Diameter (mm)		1.6	2.7	4.0	
Diamond Length (mm)		0.7	1.0	1.5	
Overall Bur Length (mm)		19.0	19.0	19.0	
Grit Size	Super-fine	SF			
	Fine	F			
	Medium	M	041-016 M	041-027 M	041-040 M
	Coarse	C	041-016 C	041-027 C	041-040 C

WHEEL Rounded Rim					
Friction Grip		067	067	068	
					
Diamond Diameter (mm)		4.0	4.8	5.4	
Diamond Length (mm)		1.5	1.8	2.4	
Overall Bur Length (mm)		16.5	16.5	19.0	
Grit Size	Super-fine	SF			
	Fine	F			
	Medium	M	067-040 M	067-048 M	068-054 M
	Coarse	C	067-040 C	067-048 C	068-054 C



CYLINDER Flat End						
Friction Grip		109	109	111	111	
						
Diamond Diameter (mm)		1.2	1.8	1.2	1.8	
Diamond Length (mm)		4.0	4.0	8.0	8.0	
Overall Bur Length (mm)		19.0	19.0	22.0	22.0	
Grit Size	Super-fine	SF				
	Fine	F				
	Medium	M	109-012 M	109-018 M	111-012 M	111-018 M
	Coarse	C	109-012 C	109-018 C	111-012 C	111-018 C





CYLINDER Beveled					
Friction Grip		129	130	131	
					
Diamond Diameter (mm)		1.2	1.2	1.2	
Diamond Length (mm)		6.0	8.0	10.0	
Overall Bur Length (mm)		20.0	22.0	23.0	
Grit Size	Super-fine	SF			
	Fine	F	129-012 F	130-012 F	131-012 F
	Medium	M	129-012 M	130-012 M	131-012 M
	Coarse	C	129-012 C	130-012 C	131-012 C





CYLINDER Round End						
Friction Grip		139	139	141	141	
						
Diamond Diameter (mm)		1.0	1.4	1.2	1.8	
Diamond Length (mm)		4.0	4.0	8.0	8.0	
Overall Bur Length (mm)		19.0	19.0	22.0	22.0	
Grit Size	Super-fine	SF				
	Fine	F	139-010 F	139-014 F	141-012 F	141-018 F
	Medium	M	139-010 M	139-014 M	141-012 M	141-018 M
	Coarse	C	139-010 C	139-014 C	141-012 C	141-018 C





CYLINDER Convex End			
Friction Grip		146	146
			
Diamond Diameter (mm)		1.2	1.6
Diamond Length (mm)		7.0	8.0
Overall Bur Length (mm)		21.0	22.0
Grit Size	Super-fine	SF	
	Fine	F	
	Medium	M	146-012 M 146-016 M
	Coarse	C	146-012 C 146-016 C

CYLINDER End Cutting			
Friction Grip		150	
			
Diamond Diameter (mm)		1.4	
Diamond Length (mm)		0.2	
Overall Bur Length (mm)		19.0	
Grit Size	Super-fine	SF	
	Fine	F	
	Medium	M	150-014 M
	Coarse	C	

CYLINDER Round Edge				
Friction Grip		156	158	
  				
Diamond Diameter (mm)		1.2	1.4	
Diamond Length (mm)		4.0	8.0	
Overall Bur Length (mm)		19.0	22.0	
Grit Size	Super-fine	SF		
	Fine	F		158-014 F
	Medium	M	156-012 M	158-014 M
	Coarse	C	156-012 C	158-014 C

CONE, Pointed						
Friction Grip		165	165	167	167	
    						
Diamond Diameter (mm)		1.2	1.6	1.2	1.8	
Diamond Length (mm)		8.0	8.0	11.0	11.0	
Overall Bur Length (mm)		22.0	22.0	25.0	25.0	
Grit Size	Super-fine	SF	165-012 SF	165-016 SF	167-012 SF	167-018 SF
	Fine	F	165-012 F	165-016 F	167-012 F	167-018 F
	Medium	M	165-012 M	165-016 M	167-012 M	167-018 M
	Coarse	C				

TAPER, Flat End						
Friction Grip		170	170	172	172	
						
Diamond Diameter (mm)		1.2	1.6	1.2	1.8	
Diamond Length (mm)		4.0	4.0	8.0	8.0	
Overall Bur Length (mm)		19.0	19.0	22.0	22.0	
Grit Size	Super-fine	SF				
	Fine	F				
	Medium	M	170-012 M	170-016 M	172-012 M	172-018 M
	Coarse	C	170-012 C	170-016 C	172-012 C	172-018 C

TAPER, Round End						
Friction Grip		196	196	198	198	
						
Diamond Diameter (mm)		1.2	2.1	1.2	2.1	
Diamond Length (mm)		4.0	4.0	8.0	8.0	
Overall Bur Length (mm)		19.0	19.0	22.0	22.0	
Grit Size	Super-fine	SF				
	Fine	F				
	Medium	M	196-012 M	196-021 M	198-012 M	198-021 M
	Coarse	C	196-012 C	196-021 C	198-012 C	198-021 C

INVERTED CONE				
Friction Grip		225	226	
				
Diamond Diameter (mm)		1.6	1.8	
Diamond Length (mm)		4.0	7.0	
Overall Bur Length (mm)		19.0	21.0	
Grit Size	Super-fine	SF		
	Fine	F		
	Medium	M	225-016 M	226-018 M
	Coarse	C	225-016 C	226-018 C

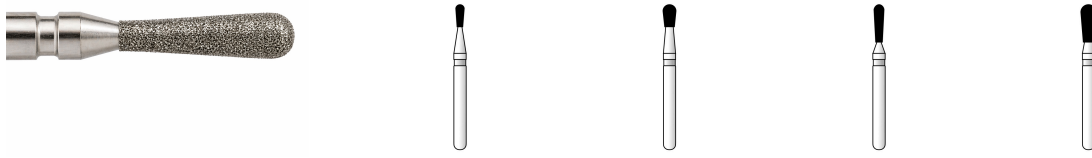
PEAR						
Friction Grip		237	237	238	238	
						
Diamond Diameter (mm)		1.2	1.8	1.4	2.1	
Diamond Length (mm)		3.0	3.0	5.0	5.0	
Overall Bur Length (mm)		19.0	19.0	19.0	19.0	
Grit Size	Super-fine	SF				
	Fine	F				
	Medium	M	237-012 M	237-018 M	238-014 M	238-021 M
	Coarse	C	237-012 C	237-018 C	238-014 C	238-021 C

FLAME						
Friction Grip			247	247	249	249
Diamond Diameter (mm)			1.0	1.4	1.0	1.6
Diamond Length (mm)			4.0	4.0	8.0	8.0
Overall Bur Length (mm)			19.0	19.0	22.0	22.0
Grit Size	Super-fine	SF	247-010 SF	247-014 SF	249-010 SF	249-016 SF
	Fine	F	247-010 F	247-014 F	249-010 F	249-016 F
	Medium	M	247-010 M	247-014 M	249-010 M	249-016 M
	Coarse	C				

BUD				
Friction Grip			257	257
Diamond Diameter (mm)			1.7	2.3
Diamond Length (mm)			5.0	5.0
Overall Bur Length (mm)			19.0	19.0
Grit Size	Super-fine	SF	257-017 SF	257-023 SF
	Fine	F	257-017 F	257-023 F
	Medium	M	257-017 M	257-023 M
	Coarse	C		

BUD, Slender			
Friction Grip		263	
			
Diamond Diameter (mm)		2.5	
Diamond Length (mm)		5.5	
Overall Bur Length (mm)		20.0	
Grit Size	Super-fine	SF	
	Fine	F	
	Medium	M	263-025 M
	Coarse	C	263-025 C

EGG					
Friction Grip		277	277	277	
					
Diamond Diameter (mm)		1.4	1.8	2.3	
Diamond Length (mm)		3.0	3.5	4.5	
Overall Bur Length (mm)		19.0	19.0	19.0	
Grit Size	Super-fine	SF	277-014 SF	277-018 SF	277-023 SF
	Fine	F	277-014 F	277-018 F	277-023 F
	Medium	M	277-014 M	277-018 M	277-023 M
	Coarse	C			

TORPEDO					
Friction Grip		288	289	290	
					
Diamond Diameter (mm)		1.2	1.4	1.4	
Diamond Length (mm)		6.0	8.0	10.0	
Overall Bur Length (mm)		20.0	22.0	23.0	
Grit Size	Super-fine	SF			
	Fine	F			
	Medium	M	288-012 M	289-014 M	290-014 M
	Coarse	C	288-012 C	289-014 C	290-014 C

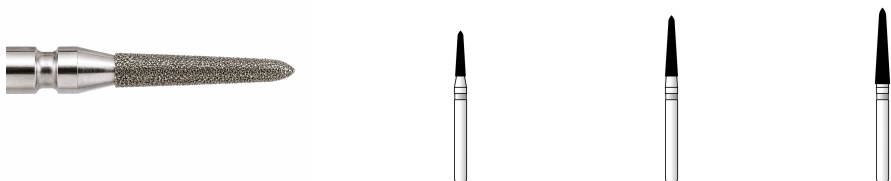
GINGIVAL CURETTAGE					
Friction Grip		297	298	299	
					
Diamond Diameter (mm)		1.4	1.7	2.0	
Diamond Length (mm)		6.0	8.0	10.0	
Overall Bur Length (mm)		20.0	22.0	23.0	
Grit Size	Super-fine	SF			
	Fine	F			
	Medium	M	297-014 M	298-017 M	299-020 M
	Coarse	C	297-014 C	298-017 C	299-020 C

LENTICULAR			
Friction Grip		304	
			
Diamond Diameter (mm)		1.6	
Diamond Length (mm)		0.5	
Overall Bur Length (mm)		19.0	
Grit Size	Super-fine	SF	
	Fine	F	304-016 F
	Medium	M	304-016 M
	Coarse	C	

INTERPROXIMAL			
Friction Grip		465	
			
Diamond Diameter (mm)		1.6	
Diamond Length (mm)		5.0	
Overall Bur Length (mm)		19.0	
Grit Size	Super-fine	SF	
	Fine	F	465-016 F
	Medium	M	465-016 M
	Coarse	C	

POINTED FLAME			
Friction Grip		496	
			
Diamond Diameter (mm)		1.2	
Diamond Length (mm)		8.0	
Overall Bur Length (mm)		22.0	
Grit Size	Super-fine	SF	
	Fine	F	
	Medium	M	496-012 M
	Coarse	C	496-012 C

CYLINDER, Guide Pin			
Friction Grip		508C	
			
Diamond Diameter (mm)		1.8	
Diamond Length (mm)		8.0	
Overall Bur Length (mm)		22.0	
Grit Size	Super-fine	SF	
	Fine	F	508C-018 F
	Medium	M	508C-018 M
	Coarse	C	

TAPER, Guide Pin			
Friction Grip		508T	
			
Diamond Diameter (mm)		2.1	
Diamond Length (mm)		9.0	
Overall Bur Length (mm)		23.0	
Grit Size	Super-fine	SF	
	Fine	F	508T-021 F
	Medium	M	508T-021 M
	Coarse	C	

CYLINDER, Gross Reduction			
Friction Grip		513	
			
Diamond Diameter (mm)		1.7	
Diamond Length (mm)		8.0	
Overall Bur Length (mm)		22.0	
Grit Size	Super-fine	SF	
	Fine	F	
	Medium	M	513-017 M
	Coarse	C	513-017 C

TAPER, Gross Reduction

Friction Grip 519



Diamond Diameter (mm) 1.7

Diamond Length (mm) 8.0

Overall Bur Length (mm) 22.0

Grit Size	Super-fine	SF	
	Fine	F	
	Medium	M	519-017 M
	Coarse	C	519-017 C

FLAME NEEDLE, Short Head

Friction Grip 539





Diamond Diameter (mm) 0.9



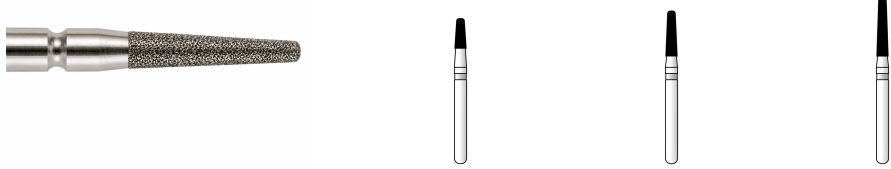

Diamond Length (mm) 3.0



Overall Bur Length (mm) 19.0

Grit Size	Super-fine	SF	
	Fine	F	539-009 F
	Medium	M	539-009 M
	Coarse	C	

TAPER, Round Edge					
Friction Grip		544	545	546	
					
Diamond Diameter (mm)		1.6	1.6	1.6	
Diamond Length (mm)		4.0	6.0	8.0	
Overall Bur Length (mm)		19.0	20.0	22.0	
Grit Size	Super-fine	SF			
	Fine	F			
	Medium	M	544-016 M	545-016 M	546-016 M
	Coarse	C	544-016 C	545-016 C	546-016 C

DEPTH MARKER					
Friction Grip		552	552		
					
Diamond Diameter (mm)		1.6	2.1		
Diamond Length (mm)		6.0	6.0		
Overall Bur Length (mm)		20.0	20.0		
Grit Size	Super-fine	SF			
	Fine	F			
	Medium	M	552-016 M	552-021 M	
	Coarse	C			

ENDO ACCESS Pointed Cone Rounded Tip				
Friction Grip		E164	E164	E164
				
Diamond Diameter (mm)		1.0	1.4	1.8
Diamond Length (mm)		10.0	10.0	10.0
Overall Bur Length (mm)		23.0	23.0	23.0
Grit Size	Super-fine	SF		
	Fine	F		
	Medium	M		
	Coarse	C	E164-010 C	E164-014 C

ENDO ACCESS Safe End				
Friction Grip		E165	E165	
				
Diamond Diameter (mm)		1.4	1.4	
Diamond Length (mm)		8.0	9.0	
Overall Bur Length (mm)		22.0	25.0	
Grit Size	Super-fine	SF		
	Fine	F		
	Medium	M		
	Coarse	C	E165-014 C	E165-014L C

ONLINE STORE:
www.dewe.dental

DEWE[®]
DIAMOND DENTAL BURS

CONTACT US

+62-21-8997-0435 (Office)
+62-817-0745-279 (Admin DEWE)
admin@dewe.dental
IG & TikTok: [@dewe.dental](https://www.instagram.com/dewe.dental)